











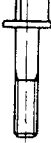

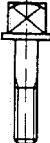
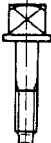
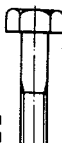
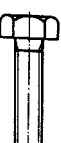
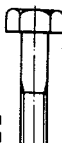
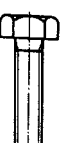

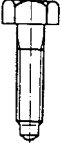

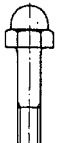
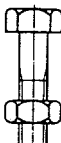

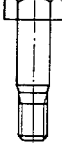
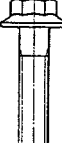
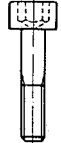
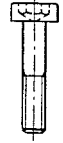
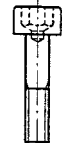
UDC 621.882.1/.6 : 621.886/.887 : 001.4



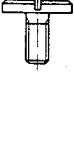

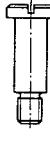

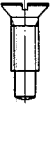
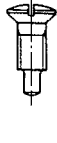







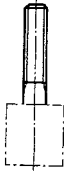











November 1987











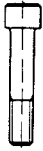
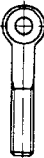
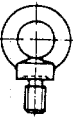

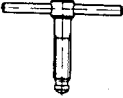

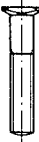
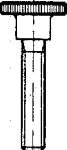

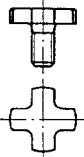
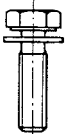
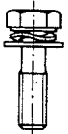
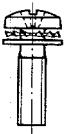
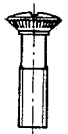
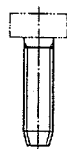

	<p style="text-align: center;">Fasteners Representation of standardized fasteners and their nomenclature</p>	<p style="text-align: center;">Supplement 1 to DIN 918</p>
<p>Mechanische Verbindungselemente; Darstellung und Namen genormter Verbindungselemente</p>		<p>Supersedes May 1982 edition.</p>
<p>This supplement provides information relating to DIN 918, but no additional standard specifications.</p>		
<p>The fasteners represented in this supplement are classified in nine groups.</p> <ol style="list-style-type: none">1 Screws, bolts and studs2 Nuts3 Washers and split pins4 Rivets5 Pins and nails6 Miscellaneous pins7 Keys and feather keys8 Adjusting rings and retaining rings9 Screw plugs10 Numerical index <p>The numbers set beneath the illustrations refer to the relevant DIN Standard(s) or draft standard(s) and are supplemented, where appropriate, by a symbol denoting the type of fastener.</p> <p>Relevant ISO Standards covering the fasteners specified in the present standard are listed in Supplement 2 to DIN 918, which compiles all the DIN Standards and ISO Standards dealing with fasteners.</p>		
<p>Continued on pages 2 to 17</p>		













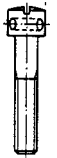





Page 2 Supplement 1 to DIN 918

1 Screws, bolts and studs

 22424	 479 21346	 480	 478	 601 931 960	 558 933	 5917 6914 70613	 961 70614	DIN ISO 4014 DIN ISO 4016	DIN ISO 4017 DIN ISO 4018
 561	 564	 7964	 25197	 7990	 609 610				
 7968 7999	 6921 6922	 912	 7984	 6912	 7991				
 84 8243	 85 8243	 920	 921	 922	 173 923 58326 58328				
 963 63 87	 964 88 91 58334	 925	 924	 7969	 7969				

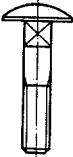
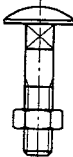

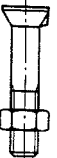
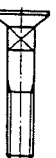
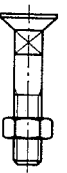
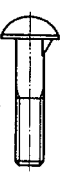
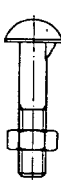
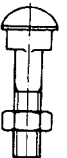
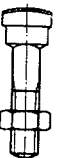

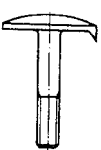
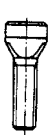

					
976	975	525	835 939 938 940		529
					
2509	2510	2510	797		
					
5914	7976	7971	7972	7973	7981
					
7982	7983	571	96	97	95
					
7996	7997	7995	6901	6901	7504



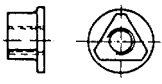
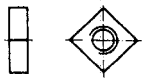
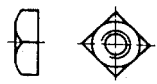

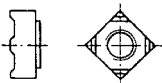
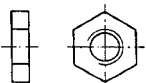
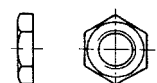
					
4626	444 81698	580		316	6304 6306
					
11014 25195	58520	464 58531	653 58530	58450	6367
					
6900	6900	6900	6900	7500	
					
427	551	417	553	438	926
					
927	913	915	914	916	6332

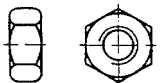
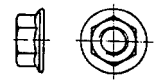
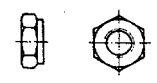
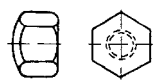
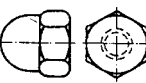
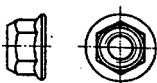
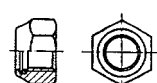
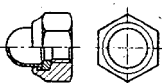
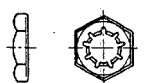
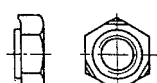
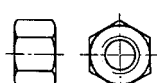
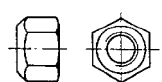
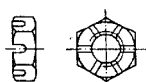
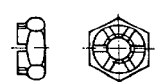
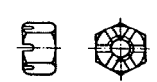
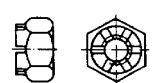
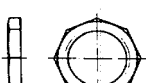
					
7985	965 7987	966 7988	404	7513	7513
					
7513	7513	7516	7516	7516	6378
					
261 25192	186 7992	188	603 63301	603	5906
					
604	604	605 608	605 608	607	607
					
5903 21647	5903	15237	25193		787

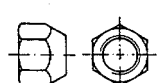

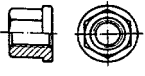
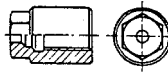
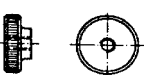
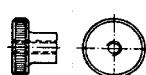

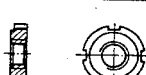

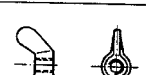
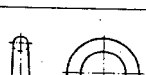
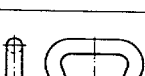
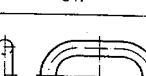
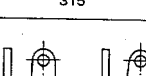
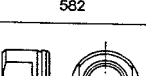
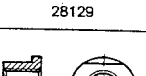
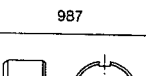
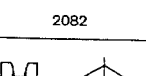
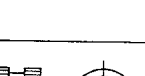
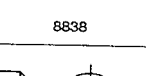
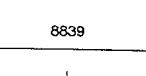
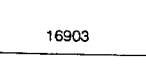
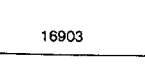
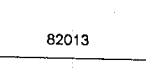
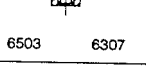
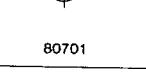
Page 6 Supplement 1 to DIN 918

2 Nuts

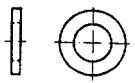
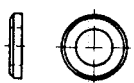
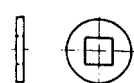
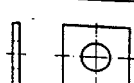
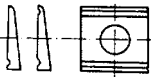
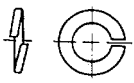
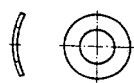

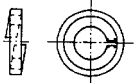
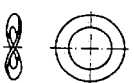
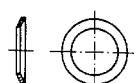

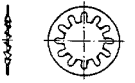
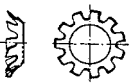
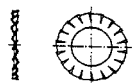

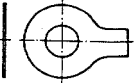
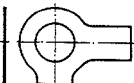
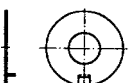
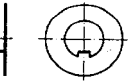
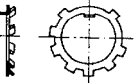
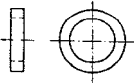
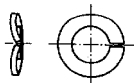
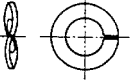
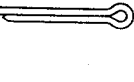
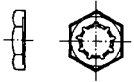
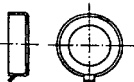

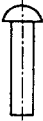
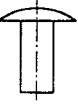

 <p>22425</p>	 <p>562</p>	 <p>557</p>	 <p>798</p>
 <p>928</p>	 <p>439 44879 DIN ISO 4034</p>	 <p>431 2950 46320 80705</p>	 <p>439 936 30389 70616 DIN ISO 4035 DIN ISO 8675</p>
	<p>555, 934, 970, 971, 972, 6915, 30386, 64032, 70615, DIN ISO 4032 DIN ISO 4034 DIN ISO 8673 DIN ISO 8674</p>	 <p>6923</p>	 <p>2510 30387</p>
 <p>917</p>	 <p>1587</p>	 <p>6926 6927</p>	 <p>980 982 985 6924 6925</p>
 <p>986</p>	 <p>7967</p>	 <p>929</p>	 <p>30389</p>
 <p>6330</p>	 <p>979 937 70618</p>	 <p>979 937</p>	 <p>935 70617</p>
 <p>935 30389</p>	 <p>431 80705</p>	 <p>74361</p>	 <p>6330 74361</p>

 <p>1142 6331 74361</p>	 <p>2510</p>		
 <p>486 58521</p>	 <p>467 6303 58521</p>	 <p>546 64032</p>	 <p>981 1804 70851 70852</p>
 <p>1816</p>	 <p>547</p>	 <p>315</p>	 <p>582</p>
 <p>80704</p>	 <p>28129</p>	 <p>987</p>	 <p>2082</p>
	 <p>8838</p>	 <p>8839</p>	 <p>16903</p>
 <p>16903</p>	 <p>82013</p>	 <p>6503 6307</p>	 <p>80701</p>
 <p>1478</p>	 <p>1479</p>	 <p>1480</p>	 <p>7965</p>

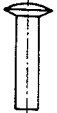
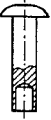
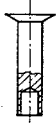
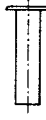

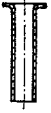
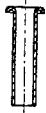
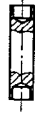

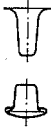
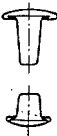







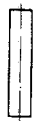



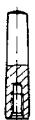











3 Washers and split pins

 <p>125 126 433 440 988 1440 1441 6902 6903 7349 7989 9021</p>	 <p>125 6916</p>	 <p>440</p>	 <p>436 5917</p>
 <p>434 435 6917 6918</p>	 <p>127 7980</p>	 <p>137</p>	 <p>127</p>
 <p>6913</p>	 <p>137 6904</p>	 <p>6796 6908</p>	 <p>6797 6906</p>
 <p>6797</p>	 <p>6797 6906</p>	 <p>6798 6907</p>	 <p>6798</p>
 <p>6798 6907</p>	 <p>93</p>	 <p>463</p>	 <p>432</p>
 <p>462</p>	 <p>5406 70952</p>	 <p>7989</p>	 <p>128 6905</p>
 <p>128</p>	 <p>94</p>	 <p>7967</p>	 <p>526</p>







4 Rivets

					
124 660	674	661	675	302	662
					
6791	6792	7338, A	7338, B	7338, C 7339 7340, A	7340, B
					
7341, A	7341, B	7331, A	7331, B	7337, A	7337, B







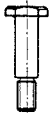









5 Pins and nails

					
7	7	7	6325	7979, C	7979, D
					
1	7978	258 7977	1144	1151, A	1160
					
1151, B	1152	1157	1158	1163	1469
					
1470	1471	1472	1473	1474	1475
		 	 		
1476	1477	1481 7346	7343 7344		

6 Miscellaneous pins

				
1433	1443	1434	1435	1436
				
1436	1444			

7 Keys and feather keys

			
6885, A	6885, B	6885, C	6885, D
			
6885, E	6885, F	6885, G	6885, H
			
6885, J	6886, A	6883	6886, B
			
6881	6889	6888	268
			
			271

8 Adjusting rings and retaining rings

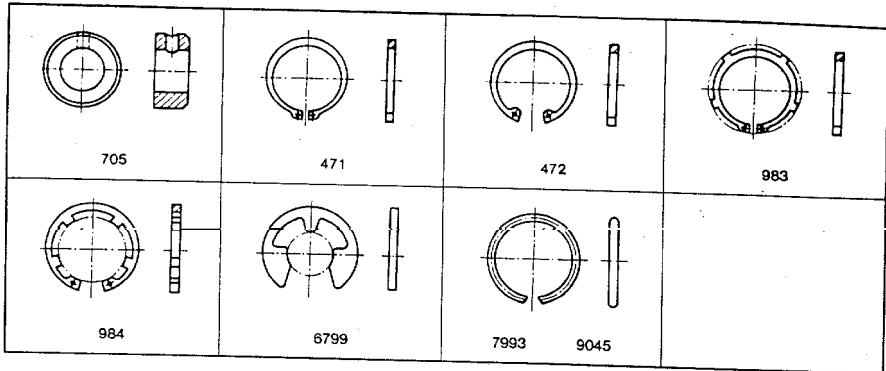

9 Screw plugs

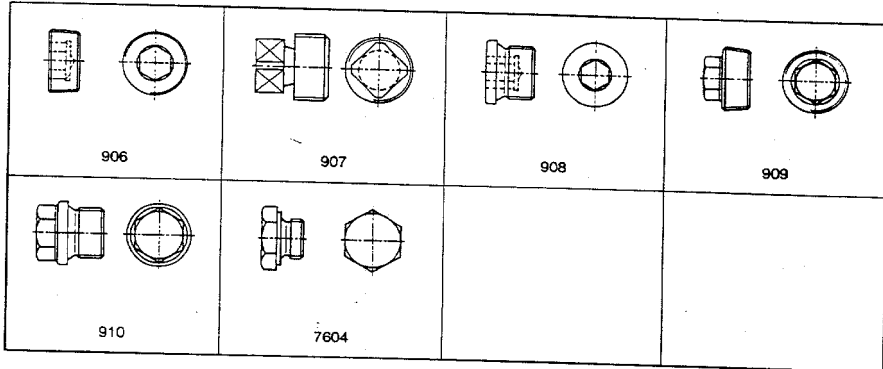

10 Numerical index

All the DIN Standards and draft standards referred to in the illustrations shown in clauses 1 to 9 are listed below. The titles are given in an abbreviated form.

DIN	Title of standard
1	Taper pins
7	Parallel pins
63	Slotted countersunk head screws with small head
84	Slotted cheese head screws
85	Slotted pan head screws
87	Slotted countersunk head screws with large head
88	Slotted raised countersunk head screws with large head
91	Slotted raised countersunk head screws with small head
93	Tab washers with long tab
94	Split pins
95	Slotted raised countersunk (oval) head wood screws
96	Slotted round head wood screws
97	Slotted countersunk head wood screws
124	Round head rivets
125	Round washers
126	Round washers
127	Spring lock washers with tang ends or square ends
128	Spring lock washers, curved or wave
137	Spring washers, curved or wave
173	Slotted pan head screws with shoulder
186	T-head bolts with square neck
188	T-head bolts with double nib
258	Taper pins with external thread
261	T-head bolts
268	Tangential keys
271	Tangential keys
302	Countersunk head rivets
315	Wing nuts
316	Wing screws
404	Slotted capstan screws
417	Slotted set screws with long dog point
427	Slotted headless screws with chamfered end
431	Pipe nuts
432	External tab washers

DIN	Title of standard
433	Washers for cheese head screws
434	Square washers for U sections
435	Square washers for I sections
436	Square washers for wood
438	Slotted set screws with cup point
439	Hexagon thin nuts
440	Round washers for wood
444	Eyebolts
462	Internal tab washers
463	Tab washers with long tab and wing
464	Knurled thumb screws
466	Knurled nuts with collar
467	Knurled nuts
471	Retaining rings for shafts
472	Retaining rings for bores
478	Square head bolts with collar
479	Square head bolts with short dog point
480	Square head bolts with collar and oval half dog point
525	Weld studs
526	Safety cups
529	Masonry and foundation bolts
546	Slotted round nuts
547	Round nuts with drilled holes in one face
548	Round nuts with set pin holes in side
551	Slotted set screws with flat point
553	Slotted set screws with cone point
555	Hexagon nuts
557	Square nuts
558	Hexagon head screws
561	Hexagon head set screw with small hexagon and full dog point
562	Square thin nut
564	Hexagon head set screw with small hexagon and coned half dog point
571	Hexagon head wood screws
580	Lifting eyebolts
582	Lifting eyenuts
601	Hexagon head bolts

Page 14 Supplement 1 to DIN 918

DIN	Title of standard
603	Mushroom head square neck bolts
604	Flat countersunk nib bolts
605	Flat countersunk square neck bolts
607	Mushroom head nib bolts
608	Flat countersunk square neck bolts
609	Hexagon fit bolts with long threaded dog point
610	Hexagon fit bolts with short threaded dog point
653	Knurled thin thumb screws
660	Round head rivets
661	Countersunk head rivets
662	Raised countersunk head rivets
674	Mushroom head rivets
675	Flat countersunk head rivets
705	Adjusting rings
787	Bolts for T-slots
797	Foundation bolts
798	Foundation nuts
835	Studs, with threaded end $2d$ long
906	Hexagon socket pipe plugs
907	Core plugs and core plug bars
908	Hexagon socket screw plugs
909	Hexagon head pipe plugs
910	Hexagon head screw plugs with shoulder
912	Hexagon socket head cap screws
913	Hexagon socket set screws with flat point
914	Hexagon socket set screws with cone point
915	Hexagon socket set screws with full dog point
916	Hexagon socket set screws with cup point
917	Hexagon cap nuts
920	Slotted pan head screws with small head
921	Slotted pan head screws with large head
922	Slotted pan head screws with small head and full dog point
923	Slotted pan head screws with shoulder
924	Slotted raised countersunk head screws with full dog point
925	Slotted countersunk head screws with full dog point
926	Slotted set screws with full dog point
927	Slotted shoulder screws

DIN	Title of standard
928	Square weld nuts
929	Hexagon weld nuts
931	Hexagon head bolts
933	Hexagon head screws
934	Hexagon nuts
935	Hexagon slotted nuts and castle nuts
936	Hexagon thin nuts
937	Hexagon thin castle nuts
938	Studs, metal end $1d$ long
939	Studs, with metal end $1,25d$ long
940	Studs, with metal end $2,5d$ long
960	Hexagon head bolts with fine pitch thread
961	Hexagon head bolts with fine pitch thread
963	Slotted countersunk head screws
964	Slotted raised countersunk oval head screws
965	Cross recessed countersunk flat head screws
966	Cross recessed raised countersunk head screws
970	Style 1 hexagon nuts
971	Hexagon nuts with metric fine pitch thread
972	Style 1 hexagon nuts
975	Threaded rods
976	Stud bolts
979	Hexagon thin slotted nuts and castle nuts
980	Prevailing torque type hexagon nuts
981	Locknuts for rolling bearings
982	Prevailing torque type hexagon nuts
983	Spring retaining rings with lugs, for shafts
984	Spring retaining rings with lugs, for use in bores
985	Prevailing torque type hexagon thin nuts
986	Prevailing torque type hexagon domed cap nuts
987	Self-locking rivet nuts
988	Shim rings and supporting rings
1142	Collar nuts for wire rope grips
1144	Nails for lightweight building boards
1151	Round wire nails
1152	Round nails with upset head
1157	Tin tacks
1158	Hook nails
1160	Wire nails with large head

DIN	Title of standard
1163	Moulding pins
1433	Headless pins
1434	Pins with small head, type m
1435	Pins with small head, type mg
1436	Pins with large head, type mg
1440	Medium type washers for pins
1441	Coarse type washers for pins
1443	Clevis pins without head
1444	Clevis pins with head
1445	Clevis pins with head and threaded portion
1469	Half-length taper grooved pins
1470	Full-length parallel grooved pins with pilot
1471	Full-length taper grooved pins
1472	Half-length taper grooved pins
1473	Full-length parallel grooved pins with chamfer
1474	Half-length reverse grooved pins
1475	Third length centre grooved pins
1476	Round head grooved pins
1477	Countersunk head grooved pins
1478	Turnbuckles made of pipe
1479	Turnbuckles made of hexagon bar
1480	Turnbuckles, forged
1481	Spring-type straight pins
1587	Hexagon domed cap nuts
1804	Slotted round nuts for machine tools
1816	Round nuts with set pin holes in side
2082	Nuts for cutter arbors
2509	Double end studs
2510	Bolts with reduced shank
2950	Hexagon nuts for fittings
4626	Spring bolts
5406	Lock washers for roller bearings
5903	Flat square countersunk bolts
5906	Clip bolts for rails up to 20 kg/m
5914	Rail screws
5917	Coupling screws
6303	Knurled nuts
6304	Tommy screws with fixed clamping bolt
6305	Tommy nuts with fixed clamping bolt
6306	Tommy screws with moveable clamping bolt

DIN	Title of standard
6307	Tommy nuts with moveable clamping bolt
6325	Parallel pins, hardened
6330	Hexagon nuts 1,5 d high
6331	Hexagon nuts 1,5 d high, with collar
6332	Grub screws with thrust point
6367	Cutter retaining screws
6378	Clip bolts
6791	Semi-tubular pan head rivets
6792	Semi-tubular countersunk head rivets
6796	Conical spring washers
6797	Toothed lock washers
6798	Serrated lock washers
6799	Retaining washers
6881	Saddle keys
6883	Parallel keys
6884	Gib-head parallel keys
6885	Keys
6886	Taper keys
6887	Gib-headed keys
6888	Woodruff keys
6889	Gib-head saddle keys
6900	Screw assemblies
6901	Tapping screw assemblies
6902	Washers for screw assemblies
6903	Washers for tapping screw assemblies
6904	Curved spring washers for screw assemblies
6905	Spring washers for screw assemblies
6906	Lock washers for screw assemblies
6907	Serrated lock washers for screw assembly
6908	Conical spring washers for screw assembly
6912	Hexagon socket thin head cap screws with centre
6913	Spring lock washers with safety ring
6914	Hexagon bolts with large width across flats
6915	Hexagon nuts-with large width across flats
6916	Washes for high-tensile bolting
6917	Square washers for I-sections
6918	Square washers for channels
6921	Hexagon flange bolts
6922	Hexagon flange bolts with reduced shank
6923	Hexagon nuts with flange

DIN	Title of standard
6924	Prevailing torque type hexagon nuts
6925	Prevailing torque type all-metal hexagon nuts
6926	Prevailing torque type hexagon nuts with flange
6927	Prevailing torque type all-metal nuts with flange
7331	Compression rivets
7337	Blind rivets
7338	Rivets for brake and clutch linings
7339	One-piece full tubular rivets
7340	Tubular rivets
7341	Rivet pins
7343	Normal-duty type spiral pins
7344	Heavy-duty type spiral pins
7346	Light-duty spring-type straight pins
7349	Plain washers for bolts with clamping sleeves
7500	Thread-forming screws
7504	Self-drilling screws
7513	Slotted thread-cutting screws
7516	Cross recessed head thread-cutting screws
7604	Hexagon head screw plugs
7964	Hexagon screws with reduced shank
7965	Screwed inserts
7967	Prevailing torque nuts
7968	Hexagon fit bolts for structural steelwork
7969	Hexagon bolts for structural steelwork
7971	Slotted cheese head tapping screws
7972	Slotted countersunk (flat) head tapping screws
7973	Slotted raised countersunk (oval) head tapping screws
7976	Hexagon head tapping screws
7977	Taper pins with thread end (with constant point length)
7978	Taper pins with internal thread
7979	Parallel pins with internal thread
7980	Spring lock washers with square ends for cheese head screws
7981	Cross recessed pan head tapping screws
7982	Cross recessed countersunk (flat) head tapping screws
7983	Cross recessed raised countersunk (oval) head tapping screws
7984	Hexagon socket thin head cap screws

DIN	Title of standard
7985	Cross recessed raised cheese head screws
7987	Cross recessed countersunk (flat) head screws
7988	Cross recessed raised countersunk (oval) head screws
7989	Washers for structural steelwork
7990	Hexagon bolts for structural steelwork
7991	Hexagon socket countersunk (flat) head cap screws
7992	T-head bolts with large head
7993	Round wire snap rings
7995	Cross recessed raised countersunk oval head wood screws
7996	Cross recessed pan head wood screws
7997	Cross recessed countersunk (flat) head wood screws
7999	High strength hexagon fit bolts for structural steelwork
8243	Slotted cheese head screws
8838	Cutter arbor nuts
8839	Differential nuts
9021	Plain washers with large outside diameter
9045	Snap rings
11 014	Flat countersunk double-nib bolts
15 237	Seating bolt
16 903	Insert nuts for plastics
21 346	Square bolts for wooden guides
21 547	Cup oval neck bolts
22 424	Triangle head bolts
22 425	Triangle nuts
25 192	T-head bolts for rail vehicles
25 193	Mushroom head anchor screws for rail vehicles
25 195	Countersunk bolts with double nib for rail vehicles
25 197	Cap bolts for rail vehicles
28 129	Stirrup bolts
30 386	Hexagon nuts with trapezoidal thread
30 387	Shouldered nuts with metric fine pitch thread or trapezoidal thread
30 389	Hexagon and castle nuts with round thread
44 879	Hexagon thin nuts for tubular heating elements
46 320	Screwed glands
58 326	Shoulder screws for orthopaedics

Supplement 1 to DIN 918 Page 17

DIN	Title of standard
58 328	Shoulder screws for side bars with ball bearing (orthopaedics)
58 334	Ankle screws (orthopaedics)
58 450	Slotted raised cheese head screws (scale screws)
58 520	Screws for drawing instruments
58 521	Knurled nuts for drawing instruments
58 530	Adjusting screws for drawing instruments
58 531	Clamping screws for drawing instruments
63 301	Mushroom head bolts (for looms)
64 032	Hexagon and slotted nuts for ring spindles
70 613	Hexagon bolts with small width across flats
70 614	Hexagon bolts with small width across flats
70 615	Hexagon nuts with small width across flats
70 616	Hexagon nuts with small width across flats

DIN	Title of standard
70 617	Hexagon slotted nuts and castle nuts (automobile construction)
70 618	Hexagon thin castle nuts (automobile construction)
70 851	Groove nuts (automobile construction)
70 852	Groove nuts (automobile construction)
70 952	Locking plate (automobile construction)
74 361	Wheel fastening nuts (automobile construction)
80 701	Tommy nuts (shipbuilding)
80 704	Bow nuts (shipbuilding)
80 705	Thin nuts (shipbuilding)
81 698	Eyebolts (shipbuilding)
82 013	Round nuts (shipbuilding)

Standards referred to

See clause 10.

Previous edition

Supplement 1 to DIN 918: 05.82.

Amendments

In comparison with the May 1982 edition, new standards have been added and references updated.

International Patent Classification

F 16 B 3/00
 F 16 B 17/00
 F 16 B 19/00
 F 16 B 21/00
 F 16 B 35/00
 F 16 B 37/00
 F 16 B 39/00